

# Fluid Cooling Shell & Tube EC Series

## COPPER & STEEL CONSTRUCTION

### Features

- Rugged Steel Shell Construction
- 3/8" Tube Size
- Larger Shell Diameter than EK, 8.50" Dia Max
- High Flow Capacity & Performance
- High Efficiency Finned Bundle Design
- Optional Patented Built-in Surge-Cushion® Bypass
- End bonnets removable for easy tube cleaning
- Mounting brackets included – may be rotated for simple installation
- NPT, SAE, BSPP, BSPT or flange connections
- Optional type 316 stainless steel or 90/10 copper-nickel components available

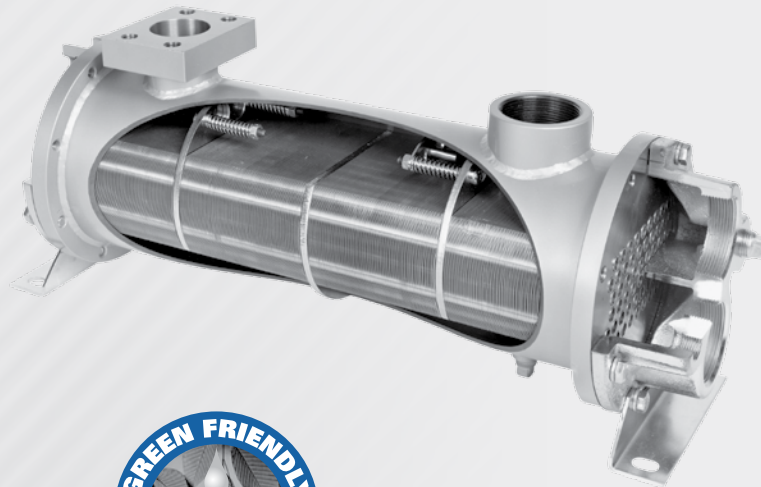

Cutaway view shows high performance copper tube/aluminum fin cooling chamber with patented SURGE-CUSHION® relief bypass valve, and optional flange connections.

WATER COOLED EC

### Ratings

**Operating Pressure** 300 psi  
**Test Pressure** 150 psi  
**Operating Temperature** 300° F

### Materials

**Shell** Steel  
 **Tubesheets** Steel  
 **Tubes** Copper  
 **Baffles** Steel  
 **Mounting Brackets** Steel  
 **Gaskets** Nitrile Rubber/Cellulose Fiber  
 **Nameplate** Aluminum Foil  
 **Fins** Aluminum  
 **End Caps** Grey Iron

### Surge-Cushion (Option)

The SURGE-CUSHION® is a protective device (patented) designed to internally bypass a portion of the oil flow during cold start conditions, or when sudden flow surges temporarily exceed the maximum flow allowed for a given cooler. This device may replace an external bypass valve, but it is not intended to bypass the total oil flow.

## How to Order

<input type="text"/>	-	<input type="text"/>	-	<input type="text"/>	-	<input type="text"/>	-	<input type="text"/>	-	<input type="text"/>	-	<input type="text"/>	-	<input type="text"/>		
<b>Model Series</b>		<b>Model Size Selected</b>		<b>Baffle Spacing</b>		<b>Tube Side Passes</b>		<b>Surge Cushion</b>		<b>Cooling Tube Material</b>		<b>End Bonnet Material</b>		<b>Tubesheet Material</b>		<b>Zinc Anodes</b>
EC ECS ECM ECF ECFM						O - One Pass T - 2 Pass F - 4 Pass		Blank - No Valve R - Value Included		Blank - Copper CN - CuNi SS - 316 Stainless Steel		Blank - Cast Iron B - Bronze SB - 316 Stainless Steel		Blank - Steel W - CuNi S - 316 Stainless Steel		Blank - None Z - Zinc Anodes

EC = NPT Oil connections; NPT Water connections.  
 ECS = SAE O-Ring Oil connections; NPT Water connections.  
 ECM = BSPP Oil connections; BSPP Water connections.  
 ECF = SAE 4 Bolt Flange (Tapped SAE) Oil connections; NPT Water connections.  
 ECFM = SAE 4 Bolt Flange (Tapped Metric) Oil connections; BSPP Water connections.

# Dimensions

## One Pass

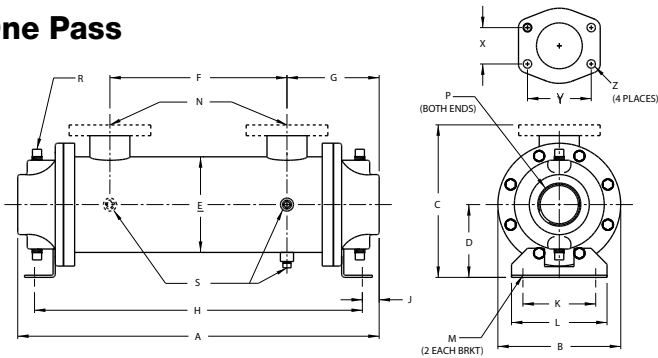

SAE Flange Size	X	Y	Z
1-1/2	1.41	2.75	1/2 - 13
2	1.69	3.06	UNC-2B
3	2.44	4.19	5/8 - 11 UNC 2B

MODEL	A	B	C		D	E	F	G	H	J	K	L	M	N		P	R	S
			NPT / BSPP SAE O-RING	SAE FLANGE										NPT/BSPP FLANGE	SAE O-RING			
EC-1014	20.22	6.75 DIA.	7.75	8.00	4.00	5.25 DIA.	10.12	5.05	18.38	.92	4.00	5.25	.50 x .75 SLOT	1-1/2	#24 SAE	2	(4) 3/8	(3) 3/8
EC-1024	30.22						20.12		28.38									
EC-1036	42.22						32.12		40.38									
EC-1054	60.22						50.12		58.32									
EC-1224	30.72	7.75 DIA.	8.75	9.38	4.50	6.25 DIA.	18.97	5.87	27.84	1.43	5.00	6.25	2	#32 SAE	3	(4) 3/8		
EC-1236	42.72						30.97		39.84									
EC-1254	60.72						48.97		57.84									
EC-1272	78.72						66.97		75.84									
EC-1724	32.22	10.50 DIA.	11.50	12.50	5.75	8.50 DIA.	18.75	7.23	29.25	1.99	7.00	8.25	.62 x .88 SLOT	3	N/A	4	(4) 3/8	
EC-1736	45.22						30.75		41.25									
EC-1754	63.22						48.75		59.25									
EC-1772	81.22						66.75		77.25									
EC-1784	43.22						78.75		89.25									

NOTE: We reserve the right to make reasonable design changes without notice. All dimensions are in inches.

## Two Pass

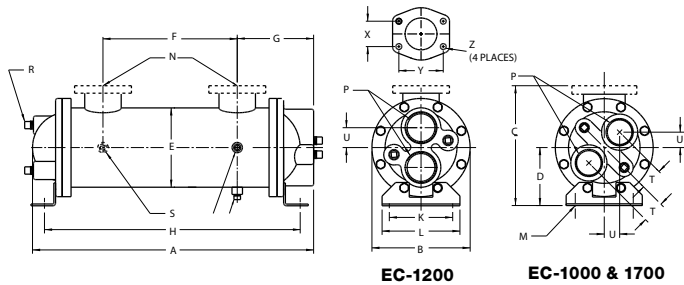

SAE Flange Size	X	Y	Z
1-1/2	1.41	2.75	1/2 - 13
2	1.69	3.06	UNC-2B
3	2.44	4.19	5/8 - 11 UNC 2B

MODEL	A	B	C		D	E	F	G	H	J	K	L	M	N		P	R	S	T	U	
			NPT / BSPP SAE O-RING	SAE FLANGE										NPT/BSPP FLANGE	SAE O-RING						
EC-1014	19.75	6.75 DIA.	7.75	8.00	4.00	5.25 DIA.	10.12	5.05	18.38	.92	4.00	5.25	.50 x .75 SLOT	1-1/2	#24 SAE	1-1/2	(4) 3/8	3/8	—	1.50	1.06
EC-1024	29.75						20.12		28.38												
EC-1036	41.75						32.12		40.38												
EC-1054	59.75						50.12		58.32												
EC-1224	29.75	7.75 DIA.	8.75	9.38	4.50	6.25 DIA.	18.97	5.44	27.84	1.00	5.00	6.25	2	#32 SAE	2	(4) 3/8	3/8	—	1.56		
EC-1236	41.75						30.97		39.84												
EC-1254	59.75						48.97		57.84												
EC-1272	77.75						66.97		75.84												
EC-1724	32.37	10.50 DIA.	11.50	12.50	5.75	8.50 DIA.	18.75	7.06	29.25	1.81	7.00	8.25	.62 x .88 SLOT	3	N/A	2	(4) 3/8	2.25	1.59		
EC-1736	44.37						30.75		41.25												
EC-1754	62.37						48.75		59.25												
EC-1772	80.37						66.75		77.25												
EC-1784	92.37						78.75		89.25												

NOTE: We reserve the right to make reasonable design changes without notice. All dimensions are in inches.

# Dimensions

## Four Pass

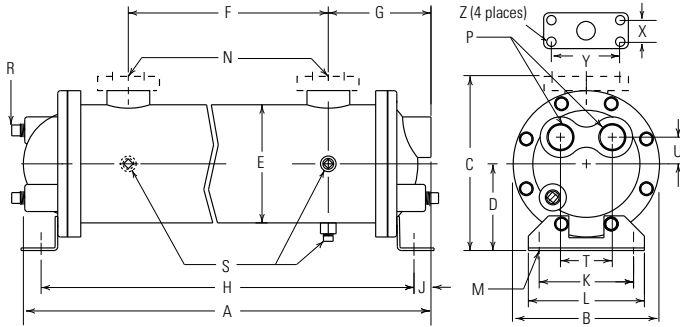

SAE Flange Size	X	Y	Z
1-1/2	1.41	2.75	1/2 - 13
2	1.69	3.06	UNC-2B
3	2.44	4.19	5/8 - 11 UNC 2B

MODEL	A	B	C		D	E	F	G	H	J	K	L	M	N		P	R	S	T	U
			NPT BSPP SAE O-RING	SAE FLANGE										NPT BSPP FLANGE	SAE O-RING					
EC-1014	19.87	6.75 DIA.	7.75	8.00	4.00	5.25 DIA.	10.12	4.82	18.38	.75	4.00	5.25	.50 x .75 SLOT	1 1/2	#24 SAE	1	(3) 3/8	(3) 3/8	2.40	1.20
EC-1024	29.87						20.12		28.38											
EC-1036	41.87						32.12		40.38											
EC-1054	59.87						50.12		58.38											
EC-1224	29.78	7.75 DIA.	8.75	9.38	4.50	6.25 DIA.	18.97	5.44	27.84	1.00	5.00	6.25	2	#32 SAE	1 1/2	(3) 3/8	(3) 3/8	2.82	1.41	
EC-1236	41.78						30.97		39.84											
EC-1254	59.78						48.97		57.84											
EC-1272	77.78						66.97		75.84											
EC-1724	31.61	10.50 DIA.	11.50	12.50	5.75	8.50 DIA.	18.75	7.06	29.25	1.81	7.00	8.25	.62 x .88 SLOT	3	N/A	2			4.25	1.41
EC-1736	43.61						30.75		41.25											
EC-1754	61.61						48.75		59.25											
EC-1772	79.61						66.75		77.25											
EC-1784	91.61						78.75		89.25											

NOTE: We reserve the right to make reasonable design changes without notice. All dimensions are in inches.

## Selection Procedure

Performance Curves are based on 100SSU oil leaving the cooler 40°F higher than the incoming water temperature (40°F approach temperature).

**Step 1 Determine the Heat Load.** This will vary with different systems, but typically coolers are sized to remove 25 to 50% of the input nameplate horsepower. (Example: 100 HP Power Unit x .33 = 33 HP Heat load.)  
If BTU/Hr. is known:  $HP = \frac{BTU/Hr}{2545}$

**Step 2 Determine Approach Temperature.**  
Desired oil leaving cooler °F – Water Inlet temp. °F =  $\frac{\text{Actual}}{\text{Approach}}$

**Step 3 Determine Curve Horsepower Heat Load.** Enter the information from above:  
 $HP \text{ heat load} \times \frac{40}{\text{Actual Approach}} \times \frac{\text{Viscosity}}{\text{Correction A}} = \frac{\text{Curve}}{\text{Horsepower}}$

**Step 4 Enter curves** at oil flow through cooler and curve horsepower. Any curve above the intersecting point will work.

**Step 5 Determine Oil Pressure Drop from Curves.** Multiply pressure drop from curve by correction factor B found on oil viscosity correction curve.  
● = 5 PSI; ■ = 10 PSI; ▲ = 20 PSI.

## Oil Temperature

Oil coolers can be selected by using entering or leaving oil temperatures.

Typical operating temperature ranges are:  
Hydraulic Motor Oil 110°F - 130°F  
Hydrostatic Drive Oil 130°F - 180°F  
Lube Oil Circuits 110°F - 130°F  
Automatic Transmission Fluid 200°F - 300°F

## Desired Reservoir Temperature

**Return Line Cooling:** Desired temperature is the oil temperature leaving the cooler. This will be the same temperature that will be found in the reservoir.

**Off-Line Recirculation Cooling Loop:** Desired temperature is the temperature entering the cooler. In this case, the oil temperature change must be determined so that the actual oil leaving temperature can be found. Calculate the oil temperature change (Oil  $\Delta T$ ) with this formula:

$$\text{Oil } \Delta T = (\text{BTU's/Hr.}) / (\text{GPM Oil Flow} \times 210)$$

To calculate the oil leaving temperature from the cooler, use this formula:

$$\text{Oil Leaving Temperature} = \text{Oil Entering Temperature} - \text{Oil } \Delta T$$

This formula may also be used in any application where the only temperature available is the entering oil temperature.

**Oil Pressure Drop:** Most systems can tolerate a pressure drop through the heat exchanger of 20 to 30 PSI. Excessive pressure drop should be avoided. Care should be taken to limit pressure drop to 5 PSI or less for case drain applications where high back pressure may damage the pump shaft seals.

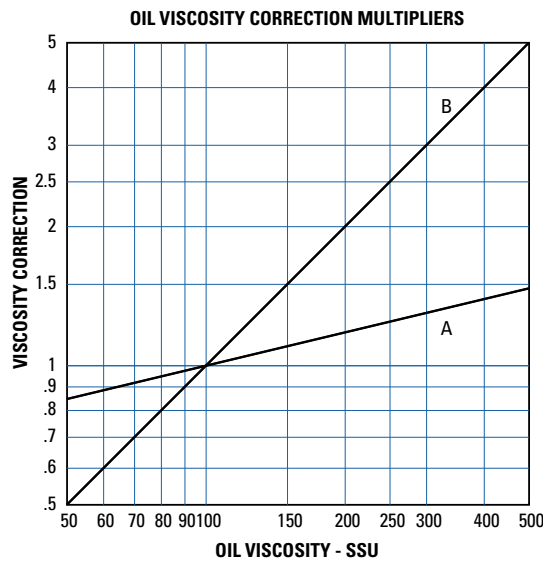

## Maximum Flow Rates

Unit Size	Shell Side GPM	Tube Side GPM		
		One Pass	Two Pass	Four Pass
1000	70	65	32	16
1200	120	120	60	30
1700	250	220	110	65

*Incorrect installation can cause premature failure.*

## Performance Curves

### 1:1 Oil to Water Ratio – High Water Usage

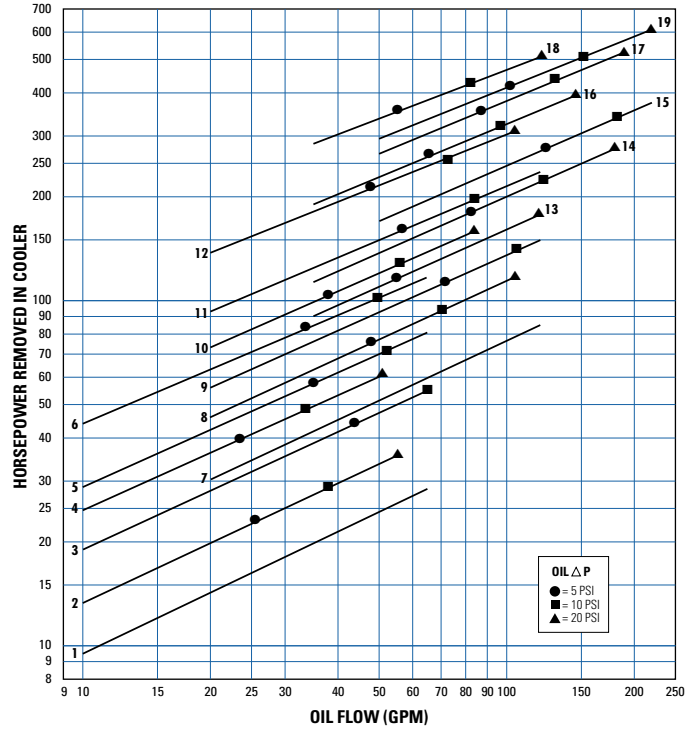

Curve Number	Model	Approx. Weights (lbs)	
		Net	Shipping
1	EC-1014-7-0	28	32
2	EC-1014-4-0	28	32
3	EC-1024-6-0	45	50
4	EC-1024-4-0	45	50
5	EC-1036-6-0	66	70
6	EC-1054-7-0	105	140
7	EC-1224-12-0	98	105
8	EC-1224-6-0	98	105
9	EC-1236-9-0	125	145
10	EC-1236-6-0	125	145
11	EC-1254-9-0	155	180
12	EC-1272-9-0	210	250
13	EC-1724-6-0	145	175
14	EC-1736-9-0	201	235
15	EC-1754-14-0	275	305
16	EC-1754-9-0	275	305
17	EC-1772-12-0	330	380
18	EC-1772-9-0	330	380
19	EC-1784-14-0	390	450

# Performance Curves

## 2:1 Oil to Water Ratio – Medium Water Usage

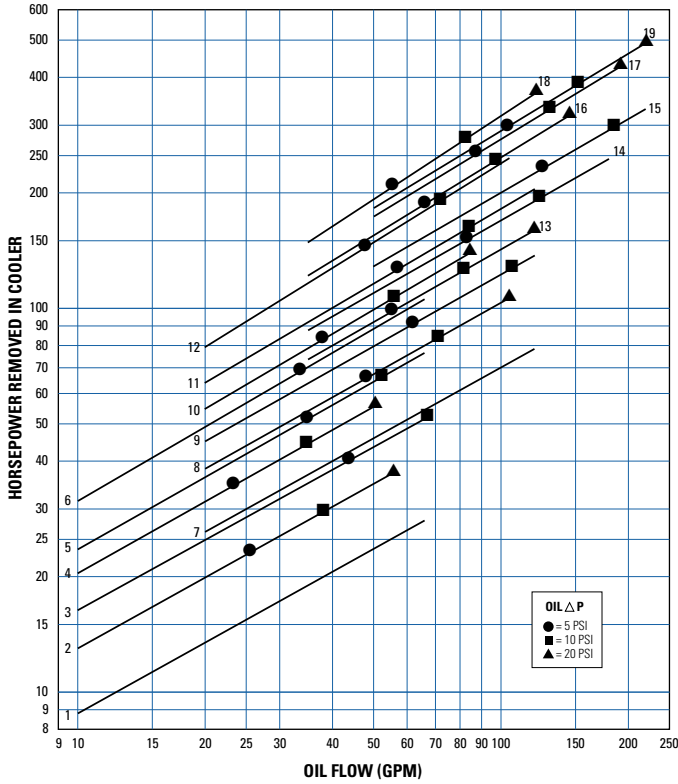

Curve Number	Model	Approx. Weights (lbs) Net	Shipping
1	EC-1014-7-T	28	32
2	EC-1014-4-T	28	32
3	EC-1024-6-T	45	50
4	EC-1024-4-T	45	50
5	EC-1036-6-T	66	70
6	EC-1054-7-T	105	140
7	EC-1224-12-T	98	105
8	EC-1224-6-T	98	105
9	EC-1236-9-T	125	145
10	EC-1236-6-T	125	145
11	EC-1254-9-T	155	185
12	EC-1272-9-T	210	250
13	EC-1724-6-T	145	175
14	EC-1736-9-T	201	235
15	EC-1754-14-T	275	305
16	EC-1754-9-T	275	305
17	EC-1772-12-T	330	380
18	EC-1772-9-T	330	380
19	EC-1784-14-T	390	450

## 4:1 Oil to Water Ratio – Low Water Usage

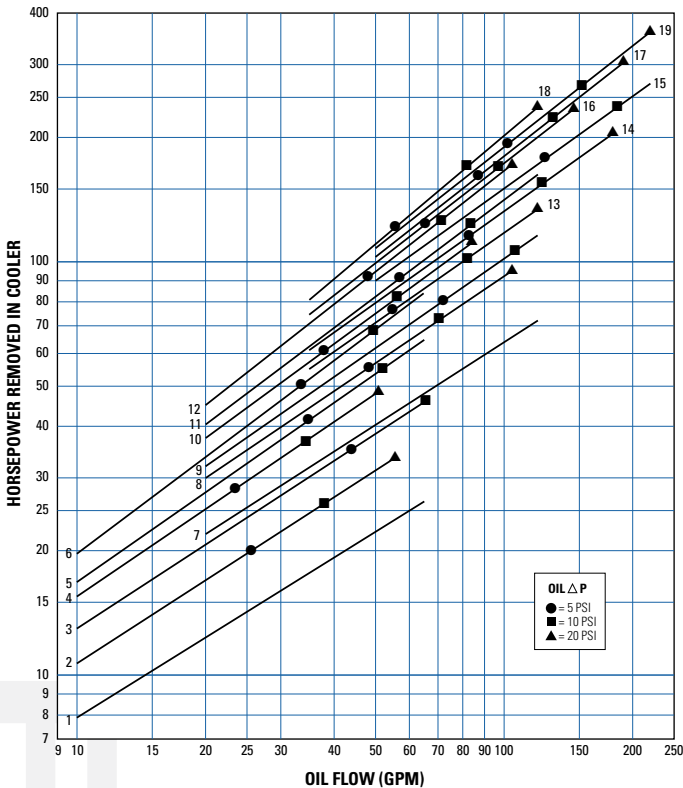

Curve Number	Model	Approx. Weights (lbs) Net	Shipping
1	EC-1014-7-F	28	32
2	EC-1014-4-F	28	32
3	EC-1024-6-F	45	50
4	EC-1024-4-F	45	50
5	EC-1036-6-F	66	70
6	EC-1054-7-F	105	140
7	EC-1224-12-F	98	105
8	EC-1224-6-F	98	105
9	EC-1236-9-F	125	145
10	EC-1236-6-F	125	145
11	EC-1254-9-F	155	180
12	EC-1272-9-F	210	250
13	EC-1724-6-F	145	175
14	EC-1736-9-F	201	235
15	EC-1754-14-F	275	305
16	EC-1754-9-F	275	305
17	EC-1772-12-F	330	380
18	EC-1772-9-F	330	380
19	EC-1784-14-F	390	450

# Performance Curves

## 7:1 Oil to Water Ratio – Lower Water Usage

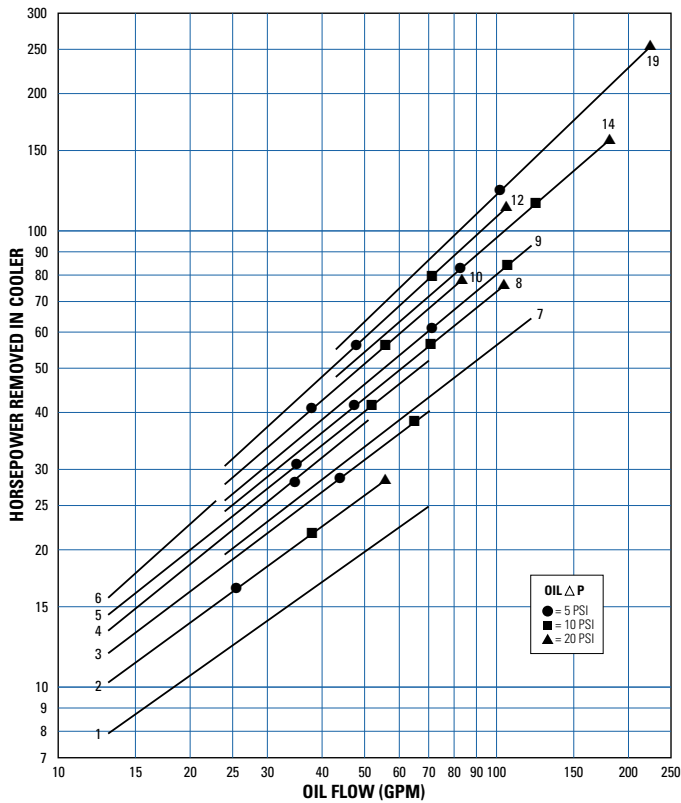

Curve Number	Model	Approx. Weights (lbs)	
		Net	Shipping
1	EC-1014-7-F	28	32
2	EC-1014-4-F	28	32
3	EC-1024-6-F	45	50
4	EC-1024-4-F	45	50
5	EC-1036-6-F	66	70
6	EC-1054-7-F	105	140
7	EC-1224-12-F	98	105
8	EC-1224-6-F	98	105
9	EC-1236-9-F	125	145
10	EC-1236-6-F	125	145
12	EC-1254-9-F	210	250
14	EC-1736-9-F	201	235
19	EC-1784-14-F	390	450

## 10:1 Oil to Water Ratio – Low Water Usage

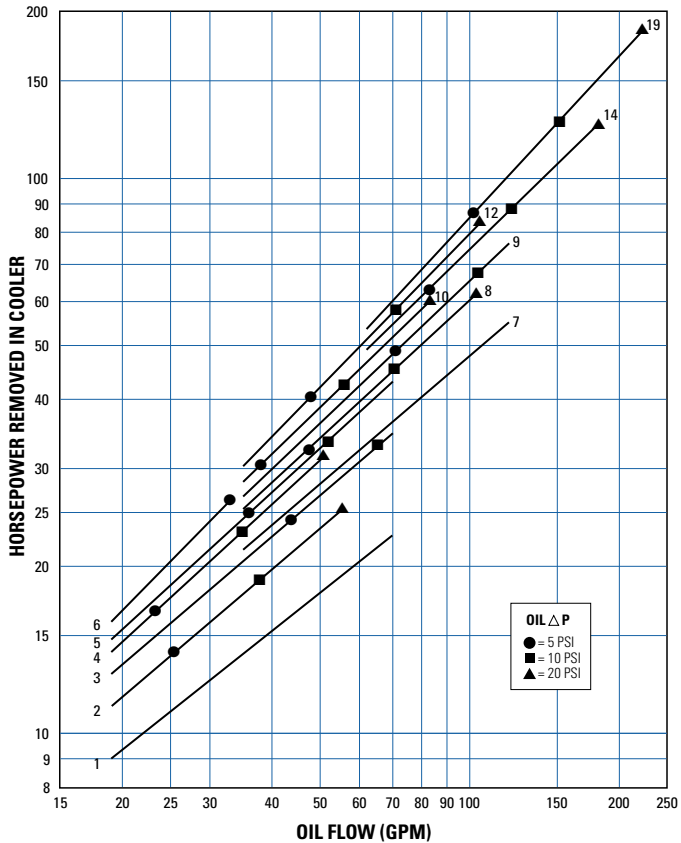

Curve Number	Model	Approx. Weights (lbs)	
		Net	Shipping
1	EC-1014-7-F	28	32
2	EC-1014-4-F	28	32
3	EC-1024-6-F	45	50
4	EC-1024-4-F	45	50
5	EC-1036-6-F	66	70
6	EC-1054-7-F	105	140
7	EC-1224-12-F	98	105
8	EC-1224-6-F	98	105
9	EC-1236-9-F	125	145
10	EC-1236-6-F	125	145
12	EC-1254-9-F	210	250
14	EC-1736-9-F	201	235
19	EC-1784-14-F	390	450